

LEVO *combi /combi JR*

INSTRUCTION MANUAL



Please read the Instruction Manual carefully before attempting to use your wheelchair. The Service Manual is provided for the use of Agents and Authorized Repairers Alterations in constructional and technical manner or to the electronic require the written authorisation of LEVO AG, otherwise no warranty or product liability will be accepted.

In case of difficulty contact:

Manufacturer:

LEVO AG
Anglikerstrasse 20
CH-5610 Wohlen
Tel:+41 (0)56 618 44 11
Fax:+41 (0)56 618 44 10
Internet: <http://www.levo.ch>

Agent:

--

Content

1	Instruction Manual	4
2	EC Declaration of Conformity.....	5
2.1	Identification:	5
3	Introduction	6
4	Positions	7
4.1	Position in seating, standing and lying	7
5	Seating and Standing Assessment	11
6	Lifetime and Warranty	13
7	Delivery.....	13
7.1	Dispatch and transportation.....	13
7.2	Delivery	15
7.3	Storage.....	15
8	Accessories	15
9	Warning	15
10	Preparing the wheelchair for use and operation	18
10.1	Headrest	18
10.2	Back pack	18
10.3	LEVO <i>combi</i> standard backrest.....	19
10.4	V-Trak backrest system (optional).....	19
10.5	Further preparations.....	19
10.6	Knee Support	19
10.7	Chest strap.....	20
10.8	Folterst	20
10.9	Weights of components which could be removed	20
	without tooling	20
10.10	Handling of removable components without tooling	21
10.10.1	Headrest	21
10.10.2	Back pack	21
10.10.3	V-Trak Backrest	21
10.10.4	Flexible Knee support	22
10.10.5	Rigid Knee Support	22
10.10.6	Chest strap	22
10.10.7	Foot Plate	22
10.10.8	Foot Rest	22
11	First adjustments.....	23
11.1	Seat depth	23
11.2	Seat cushion.....	24
11.3	Foot plate.....	25
11.4	Armrest	26
11.5	Low shearing at the back	28
11.6	Backrest assembly of the LEVO <i>combi</i> standard backrest.....	28
11.7	V-Trak backrest system (option)	28
11.7.1	Adjustments of the backrest	29
11.7.2	Adjustment of back shell	30
11.7.3	Adjustment of the head support (option)	30
11.7.4	Further adjustments of head support	31
11.8	Adjustment of the Joystick	31
12	Safety harness	32
12.1	Knee support.....	32
12.2	Adjustment of the rigid Knee Support	32
12.3	Chest strap.....	33

13	Using the LEVO combi	34
13.1	Getting into the wheelchair.....	34
13.2	Getting out of the wheelchair.....	34
13.3	Sideways transfer.....	34
13.4	Skirt guards	35
14	Main fuse.....	36
15	Installation and replacement of the Main Fuse	36
16	Release and bring the seating system into standing	37
17	Steering	38
17.1	Security key	39
17.2	On / Off switch	39
17.3	Battery indicator	39
17.4	Joystick.....	39
17.5	Speed selection.....	40
17.6	Mode functions	40
17.6.1	Standing function (standard) 40	
17.6.2	Lift function (option) 41	
17.6.3	Backrest and leg rest adjustment (option) 42	
17.6.4	Leg rest adjustment (option) 43	
17.6.5	Lying to standing function (option) 43	
17.6.6	Relax position including seat tilt (optional) 44	
17.6.7	Seat tilt function (option) 44	
17.7	Lighting installation	45
17.8	Horn.....	45
18	Electromagnetic interference (EMI)	46
19	Electromagnetic energy (EME) and electric wheelchairs	47
19.1	Behavior regarding EMI and EME.....	47
20	Driving the wheelchair.....	48
21	Motor solenoid brakes	51
22	Free wheel device / Motor disengaging lever	51
23	Batteries.....	52
23.1	Charging the batteries	52
23.2	Battery Wiring	53
24	Attendant instructions	53
24.1	Motor brakes	53
24.2	Lifting & general safety	53
24.3	General safety	53
25	Cleaning	54
25.1	Disinfection	54
25.1.1	Parts to be disinfected 54	
25.1.2	Disinfection procedure 54	
26	Maintenance.....	55
26.1	Checks and Service	55
26.2	Spare parts	55
27	Transporting your wheelchair	56
27.1	Transport in a motor vehicle without person inside	56
27.2	Transport in a motor vehicle with person inside.....	56
28	Disposal	59
29	Trouble shooting.....	60
30	Controller self help guide	61
31	Technical information	62
32	Versionsmanagement.....	63

1 Instruction Manual

Dear Customer,

We would like to thank you for putting your trust in LEVO stand-up wheelchairs.

The LEVO stand-up wheelchair is a unique aid for use by those facing difficulties walking and standing up. As well as performing all the functions of an active wheelchair, the LEVO enables you to stand up on your own.

Please read these operating instructions carefully before using your LEVO. They contain important information necessary for successful operation of the wheelchair.

Whether you use your LEVO as a stand-up aid at work in everyday life, or to help with standing exercises, it guarantees you optimum independence, mobility and health.

As a LEVO customer, you have a valuable contribution to make to the on-going further development of our products. We put great store by your suggestions, which ensure that LEVO still offers the most comprehensive service available and provides for the widest possible range of needs.

Yours faithfully,

LEVO AG

2 EC Declaration of Conformity

As manufacturer of the LEVO Stand-up wheelchair, the company

LEVO AG

Anglikerstrasse 20
CH-5610 Wohlen
Schweiz

Tel.: +41 (0)56-618 4411

Fax: +41 (0)56-618 4410

Email: office@levo.ch

Internet: http://www.levo.ch

declares under the sole responsibility that the Stand-up Wheelchair models

LEVO combi - LEVO combi JR

Product Class I

are in conformity with the provisions of the Medical Device Directive (MDD) - 93/42/EEC and the Directive 2007/47/EC and all applicable Machinery Directive 2006/42/EC.

This Declaration of Conformity includes all accessories and options of the LEVO *Combi* and is according to the Procedure of Conformity Annex VII.

The LEVO combi and LEVO combi JR are TÜV certified according EN 12184 : 2009.

2014-06-02 - Levo AG

2.1 Identification:

The serial number of the LEVO *Combi* Is placed at the rear side below the covering.

This serial number will be used only Once and is printed on the label of the chair.

Please mention the serial number in any case of communication to your dealer or support.



3 Introduction

Thank you to choose the LEVO combi.

The LEVO combi has been designed as a powered stand-up wheelchair for indoor and outdoor use. As such it belongs to the wheelchair category B.

The LEVO combi makes it possible to stand-up and to drive in a standing as well as in a sitting position; all these functions are powered. (As an option there are more functions beside sitting and standing available.) The mentioned functions provide to the users great independence.

The LEVO combi is made for everyone whose muscles do not support them to propel a wheelchair manually. The LEVO combi is a unique aid for those facing difficulties in standing and walking.

The LEVO combi has been designed for older children and adults who will benefit from motorized mobility and the ability to stand up at will.

All functions are powered and it is easy to change position by using a joystick. The standard model of the LEVO combi allows comfortable sitting and standing on every stage between the sitting and the complete standing position. Driving is possible in all stages.

As an option the LEVO combi model includes a powered seat lift and/or a reclining back. The seat tilt function comes with the seat lift in a wide range of angles and correlating to the seat height, respectively the space between the battery cover and the seat plate in a limited range. Seat tilt in combination with the backrest reclining function allows the user to be in a most comfortable position called "relax", which means the seat plate is tilted at its end, the backrest is reclined and the feet rest is raised.

As further option "lying to standing directly" can be chosen.

The wheelchair has two drive wheels in the middle, two castors at the front and one security back wheel. This construction allows easy steering. The LEVO combi is constructed with a mid wheel drive for the smallest turning circle. The turning radius is 57,5 cm or 22,6 inches.

For easier transportation it is possible to detach the back. The armrests lift up for easy sideways transfer.

The seat and backrest are fully adjustable to meet the needs of a wide range of users. The maximum load weight is 120 kilograms or 265 pounds; this includes all personal belongings carried along too.

The LEVO combi is labeled with a CE-sign. This product corresponds to the regulations notified as 93/42 EWG.

Several technical features of the LEVO combi are protected by patents. LEVO AG processes the US-Patent No. 5'964'473 and patents pending in other countries.

4 Positions

4.1 Position in seating, standing and lying



LEVO combi
in seating position
(standard)



LEVO combi
in seating position
including lift (option)



LEVO combi
in standing position
(standard)

LEVO combi
in lying position
(option)





LEVO combi
in seating position
with powered back
reclining and leg rest
(option).



LEVO combi
in seating position
with separate legrest
adjustment (option).



LEVO combi
in relax position
(option)



LEVO combi
in tilt position (option)

5 Seating and Standing Assessment

Seat depth: correct



Knee support attachment screw even with center of knee

Seat depth: too long



Knee support attachment screw beyond center of knee

Seat depth: too short



Knee support attachment screw short of center of knee



Ankle/Knee/Hip joint straight



Knee joint hyper extended



Incomplete knee

Correct position



Seat cushion too high



Cushion for pressure relief in seated position

Back too deep/thick



Backrest cushion or solid back for more comfort or stability

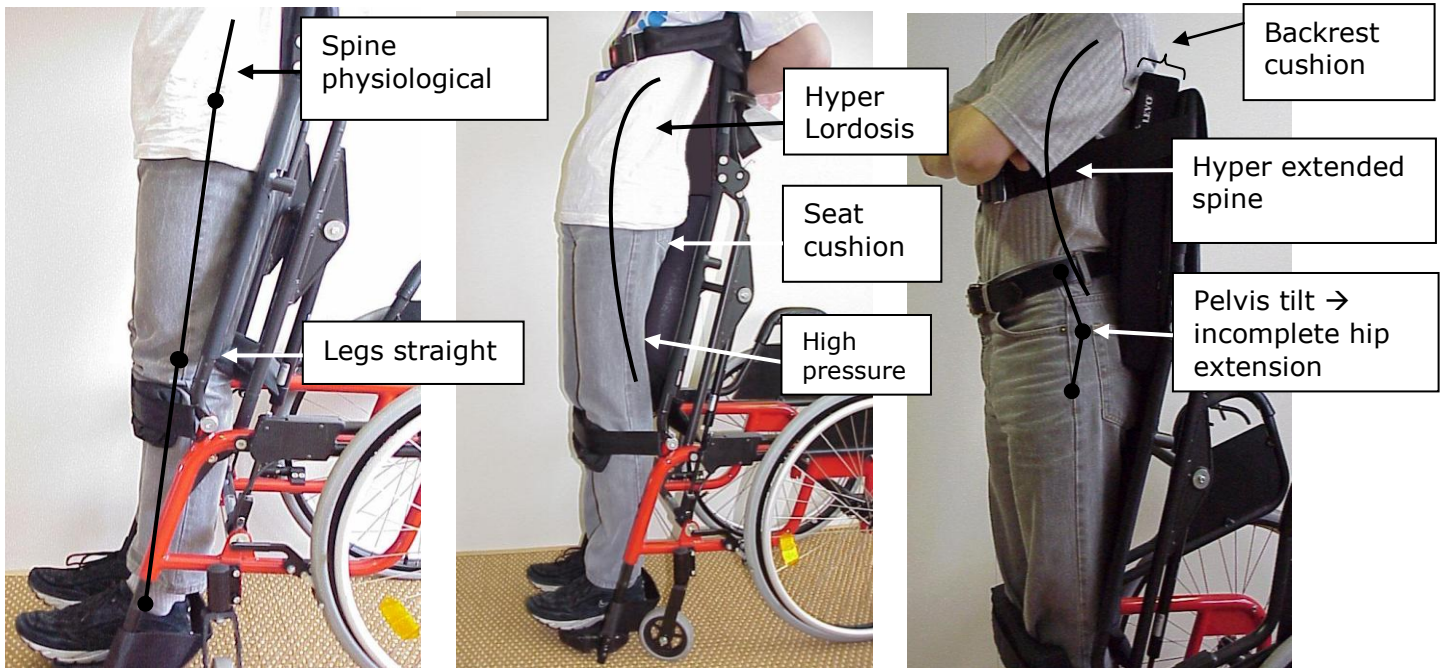

6 Lifetime and Warranty

The expected life of your LEVO Combi is at least 7 years with proper maintenance and anticipated conditions of normal use. Excluded from this life are the electronic components (especially batteries) and parts such as the seat, back, knee and arm pad.

Your **LEVO** product is guaranteed from the date of purchase for:

Two years covering all material and manufacturing defects of mechanical parts.

One year covering all electronic components including the motors.

Batteries are excluded from the warranty.

LEVO AG will not repair or replace free of charge any part or parts found to be defective due to abuse, misuse or lack of maintenance.

Warranty claims should be directed to:

In Switzerland
Other Countries

LEVO AG
To your local agent

Addresses and telephone numbers are given on the front page.

7 Delivery

7.1 Dispatch and transportation

For delivery the **LEVO combi** wheelchairs are packed on a special pallet including a big cardboard box which is strapped to the pallet (approx. L/W/H 105x75x108cm). The back is detached for careful packing. Especially sensitive parts have extra protection to avoid any damages caused by transportation.

Please note the following packing instruction.

All wheelchairs are carried by lorry or air freight.

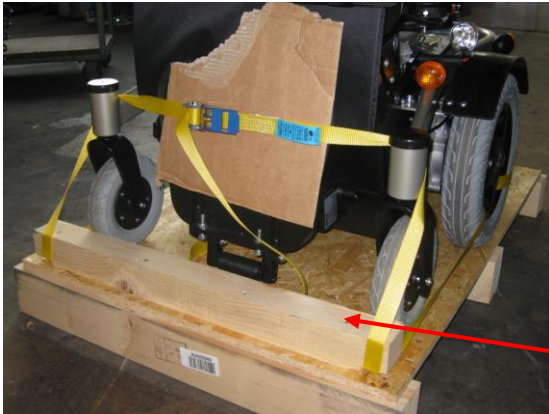

On the pallet are 2 parking positions fixed. (Pos. 1 und Pos. 2) ergänzt. Front and rear wheels has to touch these positions.

Pos.1



Pos.2



The chair will be fixed on the pallet with strapps according to the pictures.



Charger, manuals and accessories will be placed separately beneath the rear wheel.

7.2 Delivery

Because of the complex nature of this wheelchair it will be delivered and demonstrated to you by your local agent.

The wheelchair comprises the following components:

	Component	Number
	Wheelchair base	1
	Seat unit	1
	Backrest unit	1
	Knee support	1
	Chest strap	1
	Footrest	1
	Set of batteries	1
	Joystick unit	1
	Battery charger	1
	Accessories as on delivery note	Corresponding to order form

7.3 Storage

The ideal condition to store the **LEVO combi** is a temperature between -40° and $+60^{\circ}$ Celsius (between -30° and $+140^{\circ}$ Fahrenheit). The humidity should not be above 90%. Please take care to guarantee these mentioned conditions to provide a long life time for the **LEVO combi**.

8 Accessories

There are many kinds of suitable accessories to the **LEVO combi**. A list of accessories is available from your local agent.

9 Warning

For your own safety you should read and carefully follow all instructions in the manual.

- Before using the **LEVO combi**, have your **LEVO** dealer explain the instructions to you. It also helps if you have a friend to listen as well. Study the instruction manual yourself or if you cannot understand it, get a friend to help you doing so. Don't hesitate to ask for any explanation.
- The **LEVO combi** is designed for outdoor and indoor use. In principle it is not recommended to drive on uneven, soft or steeply sloping ground. Using the **LEVO combi** outdoors switch on the lights at dawn and dusk and in the dark of course.
- Avoid driving through puddles. The wheelchair and especially electrical components are very sensitive to too much water even some splashes of water

don't harm. (There is a danger of false function regarding some electrical parts getting too wet.)

- It is not recommended to drive long distances in the standing position in outdoor areas. This function is meant for moving around standing indoors, as in the kitchen or in the office for examples.
- The **LEVO combi** is a complicated piece of machinery. Do not attempt to maintain it yourself. For all maintenance work, please contact an authorized dealer. It is recommended that your authorized dealer is in charge to services the wheelchair once every year.
- Standing up stresses your body in ways you may not be used to. Therefore we recommend you to consult your doctor or physical therapist before using the **LEVO combi**.
- The **LEVO combi** is only allowed to bring you into the stand-up position when the free wheel device is "ON", this guarantees the motor brakes function correctly.
- We recommend to stand-up only when in company in case of sudden spasticity, convulsions and similar problems.

The LEVO combi with the option 90° backrest directly linked with 80° leg rest adjustment, which allows you to reach a lying position.

CAUTION: Improper balance and/or weight distribution can result in tipping over and causing serious injury or death when attempting to reach the lying- or Trendelenburg position. Trendelenburg position means that the feet will be above the head in an angle of approx. 11°. You absolutely must follow the safety precautions. Never drive in this Position!! Supervision and observation through an attendant person, wearing the safety belt, necessary fitting adjustments like leg rest, seat depth, backrest, headrest and gas spring force of the rear wheel are absolutely to observe!! Also see point 7.6., 7.7. and 11.6.

- To eliminate a potential risk of tipping while driving in the standing position, the **LEVO combi** features a tilt switch. The tilt switch system prevents to drive in the complete or almost complete standing position on ground showing a wide downtilt. Increases the downtilt to 3 degrees (only at downhill rides), it will be impossible to continue to drive in the complete or almost complete standing position. To drive on lower the seat, respectively reduce the standing angle.
- Before standing up it is absolutely vital that the knee support and chest strap are fitted correctly (see section 8) and the two back rest locking pins are properly located. Always check these pins so they are fully in place each time you use the wheelchair.
- Important: Check if the quick release axles are fitted correctly into the leg rest tubes and so the footplate is fixed securely at the leg rest pieces.

Be aware that the surface temperatures can increase when exposed to external sources of heat (e.g. sunlight).

The resistance to ignition of materials and assemblies are as follows:

- Plastic parts according to UL 94-V0
- Upholstered parts according to EN 1021-1, EN 1021-2 or ISO 7176-16

The following symbols are to be found on the wheelchair:

On the **LEVO C³** you find the following symbols attached:



Warning, risk of pinching! Make sure no parts of the body, clothing or other items get jammed



Warning, read user's manual!



Anchorage point for the tie down straps.



Label for the shutdown of the brake release

Caution: Federal law restricts this device to sale by or on the order of a medical professional licensed by the law of the State in which he /she practices.

You should under no circumstances attempt to stand up without following all safety precautions.

10 Preparing the wheelchair for use and operation

A specialist should be responsible for first adjustments and he should get the chair ready for operation.

- Please make sure that all components listed are delivered with the chair. Check the list shown in sector 3.2.

10.1 Headrest

The headrest may be taken off without tooling by a lever screw. Please release it and take it upwards out of the rail. The total height will be reduced for transportation. Please note that this headrest is important to the user. If the chair is used without headrest, heavy consequences will be in any case.

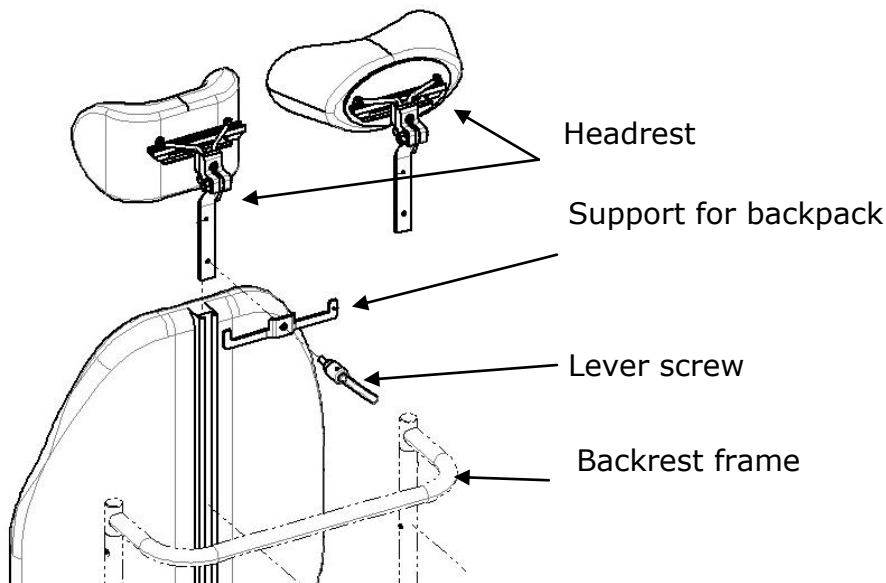

10.2 Back pack

The back pack is placed on the support.

By leaving the chair, it may be taken off easily and without no problems.

Only the weight may be reduced if the back pack is taken off.

Back pack



10.3 LEVO *combi* standard backrest

Information about the assembly of the **LEVO *combi*** standard backrest is printed under the sector 7.6. The standard backrest is not developed for quick fitting and removing.

10.4 V-Trak backrest system (optional)

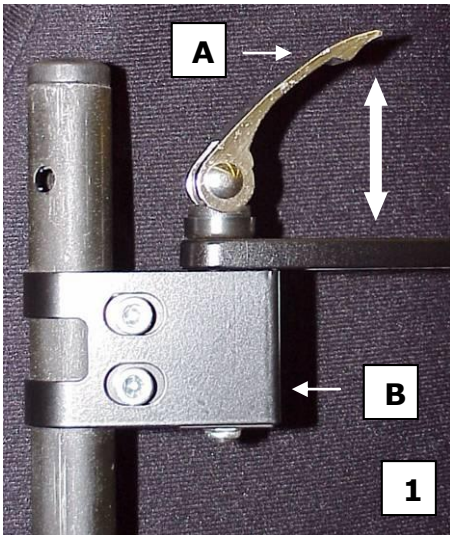

Fitting and removing the V-Trak backrest

- Lift both backrest levers (A) at the back shell the way that they can turn freely.
- Fitting:
 - For fitting the back stick the clamp bolt of both backrest levers in the tubes of the connecting piece (B) of both backrest tubes. The back shell should be in front of the backrest tubes for fitting. For fixing both backrest lever (A) push them down. (See picture 1).
- Removing:
 - For removing the back fold the backrest lever (A) up on both sides. Now lift the backrest up and remove it.

10.5 Further preparations

- Fold down the footrest.
- Put the seat upholstery on the seat. Fix the upholstery on the seat metal plate using the velcro fastener.
- Screw the joystick module to the intended holder at the armrest.
- Plug in the control cable behind the joystick module.
- Ensure that the main fuse below the battery cover is put into the device.
- Check that the free wheel device is clicked shut and the motor brakes function. (For more information about that subject consult sector 16)

10.6 Knee Support

The LEVO *combi* will be delivered with the flexible knee support or the rigid knee support Pro. The knee support positions the knee and the lower leg in place during driving and in standing. Please note that the knee support is absolutely important to use for standing. To enter or to leave the chair, the knee support has to be taken off. For correct adjustment and handling please see 9. Using the LEVO *combi*.

10.7 Chest strap

The chest strap is attached to the backrest frame. It could be opened to easy. The chest strap positions the upper body for the standing function. Going into standing without chest strap is absolutely not allowed. For correct adjustment and handling please see 9. Using the *LEVO combi*.

10.8 Folterst

- If the **LEVO Combi** will be stored or transported at a minimum dimension respectively shortened, the foot plate could be flipped up. The whole footrest may be taken off if necessary. Please note that the footrest has to be installed to use the chair.

10.9 Weights of components which could be removed without tooling

Components	Weight
Headrest	0.75 kg
Back pack	fully loaded max. 10kg
V-Trak backrest	3 kg
Flexible knee support	0.5 kg
Rigid knee support	1.5 kg
Chest strap	0.4 kg
Foot plate	3.1 kg

The heaviest without tooling removable component could be the backpack of max. 10kg.

10.10 Handling of removable components without tooling

10.10.1 Headrest

The headrest will be hold for assembling and disassembling like shown.



10.10.2 Back pack

The back pack will be hold for assembling and disassembling like shown.



10.10.3 V-Trak Backrest

The V-Trak backrest will be hold for assembling and disassembling like shown.



10.10.4 Flexible Knee support

The flexible knee support will be hold for assembling and disassembling like shown.



10.10.5 Rigid Knee Support

The rigid knee support will be hold for assembling and disassembling like shown.



10.10.6 Chest strap

The chest strap will be hold for assembling and disassembling like shown.



10.10.7 Foot Plate

The foot plate will be hold for assembling and disassembling like shown.



10.10.8 Foot Rest

Will be hold for assembling and disassembling like shown.



11 First adjustments

11.1 Seat depth

The seat depth has to be adjusted to the length of the upper legs. Precise adjustment is very important considering a perfect sitting and standing position. Let a specialist adjust your seat depth according to the measurements indicated on the order form. For an individual adjustment of the seat depth it is necessary to change four components:

1. Seat support plate
2. Both seat supports
3. Adjusting lever on the right hand side
4. Adjusting lever on the left hand side

Is the **LEVO combi** equipped with the option reclining backrest, it is also necessary to adapt the adjustable plates of the actuator for backrest reclining. (See picture 4, B)

The seat cushion is fixed on the adjustable plate of the seat support made of metal.

- Detach the seat cushion first.
- Move the seat in a more upright position using the joystick module for easier access.
- Switch off the joystick module as well as the fuse automatic.
- Remove the four adjusting screws on the seat support plate using a 4 mm hexagon key, to adjust the depth of the seat support plate. (See picture 2).

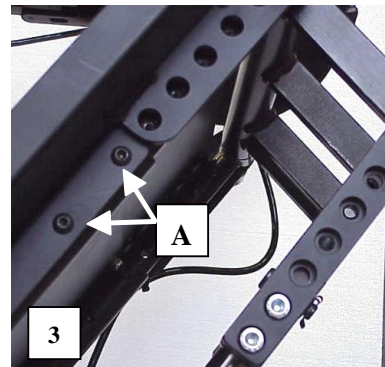
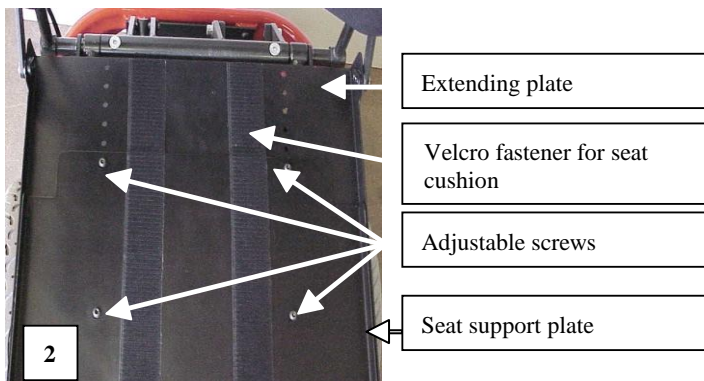

- Remove two screws (A) at each seat support using a 4 mm hexagon key. (See picture 3).
- Pull or push the seat support in the requested position and tighten the screws. (all positions must be adjusted to the same number, see positions-marks in picture 3a and 3b)
- Push the extending plate to the corresponding position and also tighten the screws. (See picture 2).

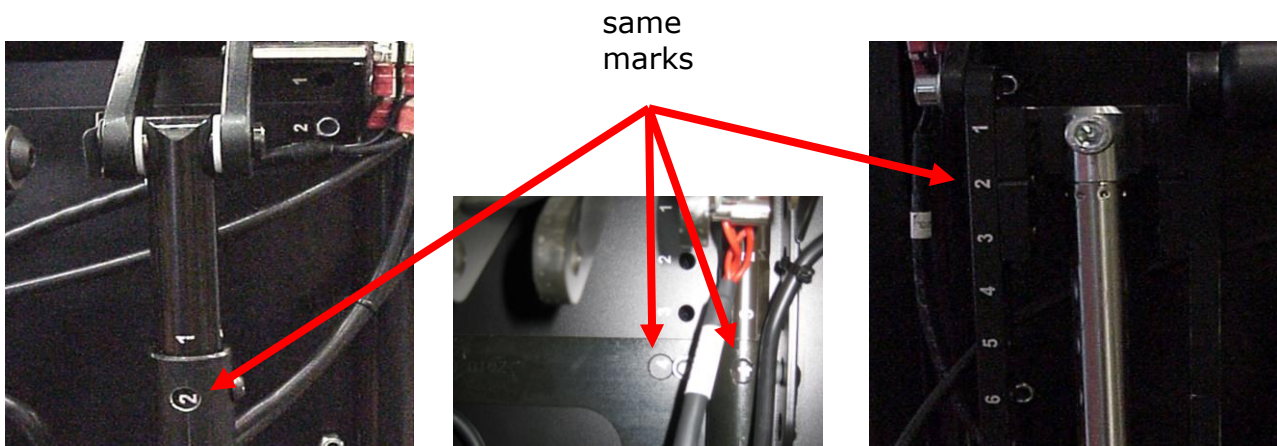

For any changes of position regarding the adjusting lever and the adjustable plates of the actuator for backrest reclining, please follow the instructions:

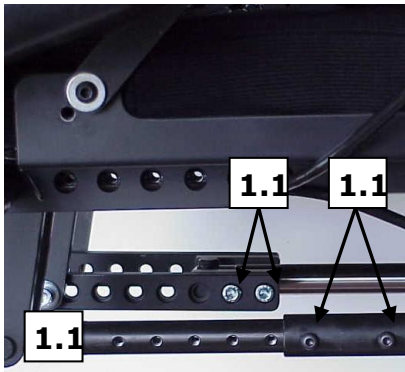

- Remove both screws (A) from the adjusting lever using a 4 mm hexagon key. (See picture 4).
- Remove all together four screws (B) from the adjusting plates of the actuator for backrest reclining using a 6 mm hexagon key. (See picture 4).
- Push or pull the adjusting lever and the adjusting plate to the correspondent position and tighten all screws.

Important: When changing the seat depth please take care that all four components (seat support, extending plate, adjustable lever and adjustable plate) are adjusted at the same time! All four components must be fixed at exactly the same position (see picture 3 and 4).

11.2 Seat cushion

The seat cushion is shaped in such a way at the front edge to provide you the most comfort and the ideal distribution of pressure. The cushion will be fixed with a Velcro fastener so it doesn't move around. To fixate just put it on the seat and push it down.

The edge in front of the cushion is shaped to cover optimally the seat. (See picture 5).



11.3 Foot plate

The adjustment of the footplate is possible in between a range of 23 cm/9,2" (14 different positions of holes (D) with a distance of 18 mm/0.07" from one to the next). At the **LEVO combi JR** this range depends on the footplate-broad. (B22 cm, 14 pos.; B30 cm, 7pos.; B40 cm, 3 pos.)

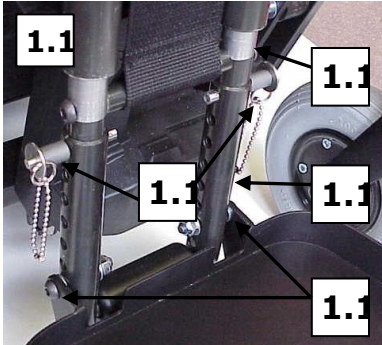

Adjust the height of the footplate removing both hexagon screws (A) by using a 6 mm and a 10 mm hexagon key (see picture 6). Lift the footplate to the requested height and tighten the screws.

In case the footplate is meant to be fixed at the most upper position, so replace the quick release axle by a hexagon screw (A).

For transportation the footplate and the leg rest tubes can be detached.

Use the lift function or put the chair in the lying position.

Push the button in the center of the quick release (B) and pull these pieces out of both leg rest. (See picture 6).

Remove the leg rest including the footplate.

At the **LEVO combi JR** (see picture 7) additionally two adjustment plates are installed (A), in order to allow for the necessary rise of the footplate at the leg supports.

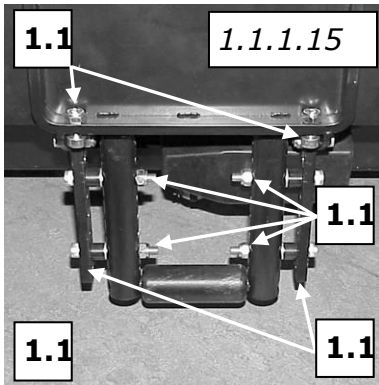

- Adjust the height of the footplate by removing the four cylindrical screws (B) using a 8 mm hexagon key (see picture 7). Lift the footplate to the desired height and install the screws again.

- For transportation the footplate and the leg rest tubes can be detached.

- Use the lift function or put the chair in the lying position.

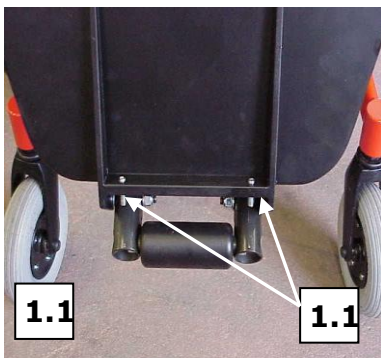

- Push the button (B) in the center of the quick release (see picture 6) and pull these pieces out of both leg rests.

- Remove the leg rests including the footplate.

- The angle of the footplate can be changed in a range from minus 5° to plus 15° to the horizontal level. To put the angle of the footplate in the requested position adjust the two threaded pins (A) below the footplate using a 6 mm hexagon key (see picture 8). Turn the



pins in or out just the way needed to get the requested angle of the footplate.

- At the combi JR normal cylindrical screws © with a lock nut (see picture 7) are installed. You loosen the lock nuts and place then the angle at the cylindrical screws. Tighten the lock nuts again.

Caution: Both pins (combi JR, cylindrical screws) must touch the leg rests (combi JR, props) when the footrests are in a flip-down position.

11.4 Armrest

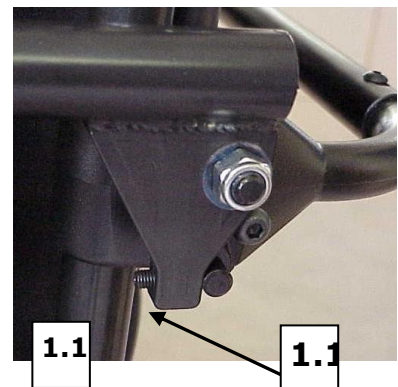
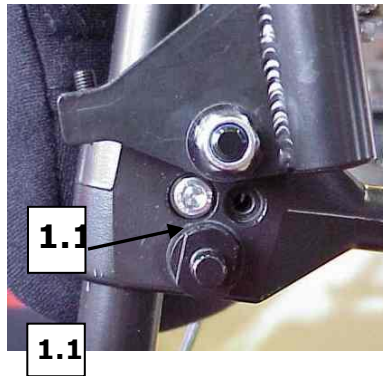

The armrest can be put in a flip-up position for an easy transfer sideways. This also allows a better access to the chair. (See picture 9).

The height of the armrests is fully adjustable in between a range of 15 cm/6" to 33 cm/13"; the height of the armrest is measured from the upper edge of the seat cushion to the upper part of the armrest.

- Loosen the cylindrical screw on either side of the armrest joints using a 5 mm hexagon key. (See picture 10).
- Now push the connecting rod and the armrest joints along the backrest tube for the ideal position.
- Tighten the cylindrical screw on the right and left side.

The angle of the armrest is also adjustable.

- For lifting the armrest in front turn the threaded pin in (B) using a 2,5 mm hexagon key. Turn the pin clock wise further in the armrest joints. (See picture 11).
- For lowering the armrest in front turn the threaded pin out (B) using a 2,5 mm hexagon key. Turn the pin counter clock wise further out of the armrest joints. (See picture 11).

The support of the joystick module can be swung away to the side and further pushed back. This allows the wheelchair user to get closer to the table.

- Push the release catch (A) to the side and backwards simultaneously (see picture 12). Now move the joystick module first to the side and then backwards.

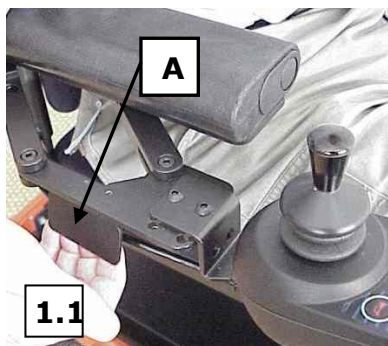

At the **LEVO combi JR** the arm rests can be shifted also laterally, i.e. inward or outward. After raising the lever A (see picture 12b) the arm rest can be fixed in three positions, in distances of 25 mm/ 1". (see picture 12c completely out, 12d completely in).

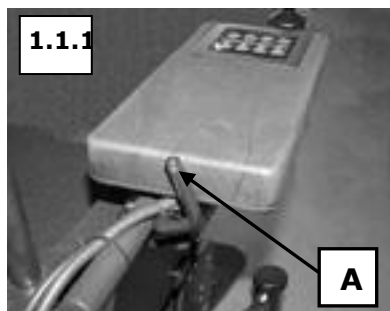

As a further option the **LEVO combi** features a tilted armrest mechanism. (see picture 24). Armrests tilting while changing position from sitting to lying provide most comfort to the user, because his arms are horizontally well-positioned and they feel continuously stable. This function is set on the program and, therefore, there is no action necessary. The tilted armrest mechanism also function reversed, that means that the armrests raise, when the chair is moved back from the lying or relaxing position to the sitting position or as well when activating the function (optional) "lying to standing directly". During both actions the armrests move in such a way that the user's arms are lying stable and comfortably on it.

Caution: Do not use the joystick as a support. Please use the armrests to support you when transferring to another chair or to the bed or back to the LEVO combi.

Caution: To prevent the risk of snapping off the joystick module, please be careful and avoid hitting the joystick against any object.

11.5 Low shearing at the back

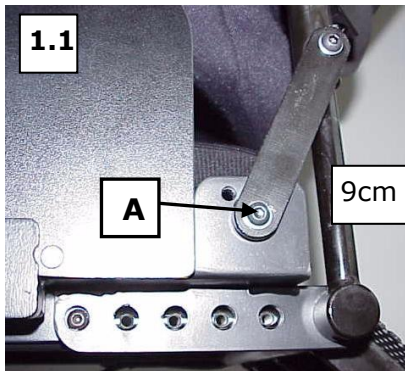

The **LEVO combi** is equipped with a new low shearing mechanism (see picture 13) which eliminates the shearing movements for most comfort as a user benefit in a sitting as well as standing position. This shearing mechanism counteracts to the shifting of the wheelchairs back towards the upper body of the user. These shifting movements were often considered as uncomfortable. Thanks to the low shearing mechanism the **LEVO combi** feels like tailor made in each position. The most comfortable stand-up motion is also realized by the fact that the distance between the armrest and shoulders stays constantly the same.

The new unique low shearing mechanism is adjustable to the individual body measurements using correlatively one of the three different positions to mount the connecting piece (A).

As a standard the connecting piece is fixed to middle drill hole; this means the medium adjustment and the compensation of 9 cm / 3.5". Fixing the connecting piece on one of the other holes the compensation will be of 8 cm / 3", respectively 10 cm / 4". Please read the service instructions for more information about this subject. (Service instruction section 8.7.)

11.6 Backrest assembly of the LEVO combi standard backrest

The standard backrest consists of a fabric covering. Around the backrest tubes are four strong broad straps with stitched on Velcro fastener mounted. The straps are hidden under a cover which is fixed with a Velcro fastener to the seat plate. The cover is lightly cushioned and is positioned over the front of the backrest. The back part is covered by a strong fabric.

Adjustment of the backrest: The standard backrest can be individually adjusted.

- Remove the back cover from the backrest to get access to the straps.
- Span each of the four straps individually according the needs of the user to optimize the support in the sitting position.
- Put the back cover back in place.
- The LEVO combi comes with the option 90° back angle directly linked with 90° leg rest angle adjustment. In this case you must choose a suitable and stable backrest system to be mounted. Again, this must be mounted in such a stable way, that it cannot be moved or pivoted through weight or balance point shifting in any position by its self.

11.7 V-Trak backrest system (option)

The **LEVO combi** can be supplied optionally with the V-Trak backrest system, which guarantees most comfortable sitting. The V-Trak system provides features for most individual adjustment. The backrest consists of a comfortable padded adjustable back shell and a fully adjustable mounting system. A backrest of 63 cm / 25 inches length is known as a V-Trak standard. Further options are available such as a head support for example.

With the option 90° back angle directly linked with 90° leg rest angle adjustment, the V-Trak must be mounted in such a stable way, that it cannot be moved or pivoted through weight or balance point shifting in any position by its self. Two central supports are essential.

For more information about the backrest systems please contact an authorized dealer.

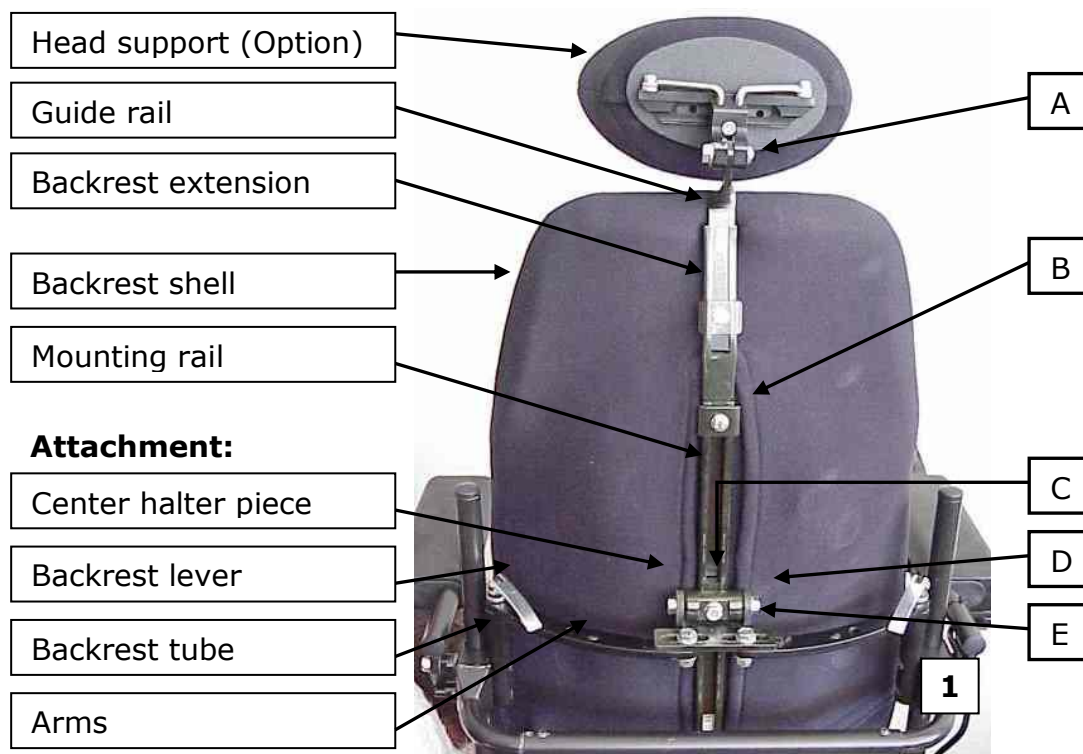

11.7.1 Adjustments of the backrest

Backrest depth:

- Loosen the two arm pivot bolts and nuts (E) using a 13 mm spanner. Move the backrest forwards or backwards to the desired location (see picture 14).
- Retighten the bolts and nuts.

Backrest height:

- Loosen the height set bolts © using a 13 mm spanner.
- Move the backrest up or down to the desired location (see picture 14).
- Retighten the bolts.

Backrest rake (recline):

- Loosen the two rake set bolts (D) using a 13 mm spanner. Rotate the backrest to the desired location (see picture 14).
- Retighten the bolts.

The backrest can be even adjusted asymmetric or sidewise. For further informations please contact your local specialist.

11.7.2 Adjustment of back shell

The tension of the backrest cushion can be changed as follows:



- Peel back the rear cover of the backrest to expose the adjustment straps.
- Put finger through loop as shown and pull the strap off the Velcro fastener (see picture 15).
- Increase or decrease the tension on the strap to the desired level and press the strap down onto the Velcro fastener.
- Repeat for each strap. When you are satisfied with the tension on the cushion refit the rear cover.

11.7.3 Adjustment of the head support (option)

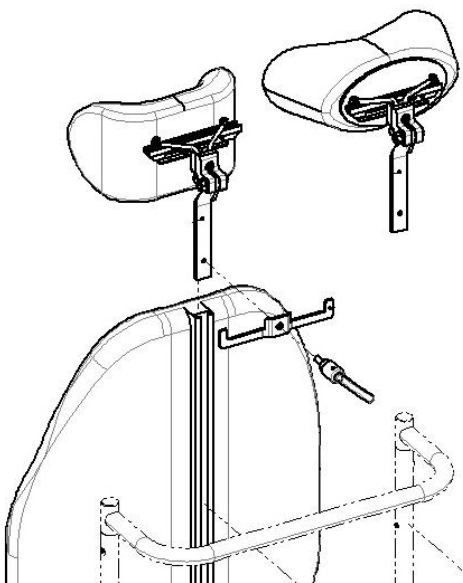

- To remove the head support, loosen the screw (B) with a spanner number 10.
- Lift the head support (see picture 14).
- To refit the head support, push the guide rail of the head support into the mounting rail.

Further adjustments of head support

- To adjust the angle of the head support, loosen the screw (A) using a 10 mm screwdriver.
- Retighten the screw.
- For the adjustment of the head support rake loosen the screw (A) and retighten it at the desired position. (See again picture 14).

Important: To mount a head support to a 63 cm/25" or an 80 cm/31.5" back rest ex post there is a rail extension necessary.

For additional adjustment of the backrest as well as for information about accessories to the backrest please contact your local specialist.

11.7.4 Further adjustments of head support

- To adjust the angle of the head support, loosen the screw (A) using a 10 mm screwdriver.
- Retighten the screw.
- For the adjustment of the head support rake loosen the screw (A) and retighten it at the desired position. (See again picture 14).

Achtung: um eine Kopfstütze an eine 60 cm oder 80 cm hohen V-Trak Rückenschale anzubringen, braucht es eine Schienenverlängerung (spezielles Zubehörteil)!

Für zusätzliche Anpassungen der Rückenlehne sowie Informationen über weiteres Zubehör zur Rückenlehne wenden Sie sich bitte an Ihre Fachperson.

11.8 Adjustment of the Joystick

By driving into an obstacle, the joystick may misalign. Please adjust it according following instruction.

- Release the two screws (A)
- adjust the joystick
- tighten the screws

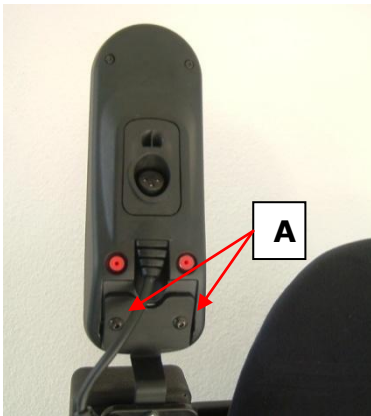

12 Safety harness

The safety harness consists of two parts: a chest strap and a knee support.

Caution: Before attempting to stand in your wheelchair fit and adjust the chest strap and the knee support.

12.1 Knee support

The knee support helps your knee not to bow in the standing position; you are standing with your legs totally stretched. Beside that the knee support keeps you in the perfect position during the stand-up motion.



- Attach the two eyes of the knee support to the big double-head screw on either side of the wheelchair (A).
- (See picture 16).
- Fit the knee support over your legs so that the knee wedge is between your legs (B). Close the quick release catch on the belt.
- The knee support should be just below the kneecap (max. 2 finger widths). Tighten the belt until there is just enough room to insert a hand between the support and your leg.

12.2 Adjustment of the rigid Knee Support

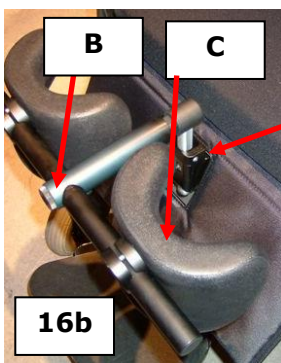

Place the rigid knee support from the front side into the bracket A. Assure that the knee support is locked properly. By tighten/untighten of the knurled head screw B, the distance between the knee pad and the knee could be adjusted. The position of the knee pad in height could be adjusted by the screws D.

For a correct adjustment please keep in contact with a specialist.

12.3 Chest strap

The chest strap is positioned by a bracket at the backrest frame. Untighten the screw and adjust the bracket in the height. Then tighten the screw.

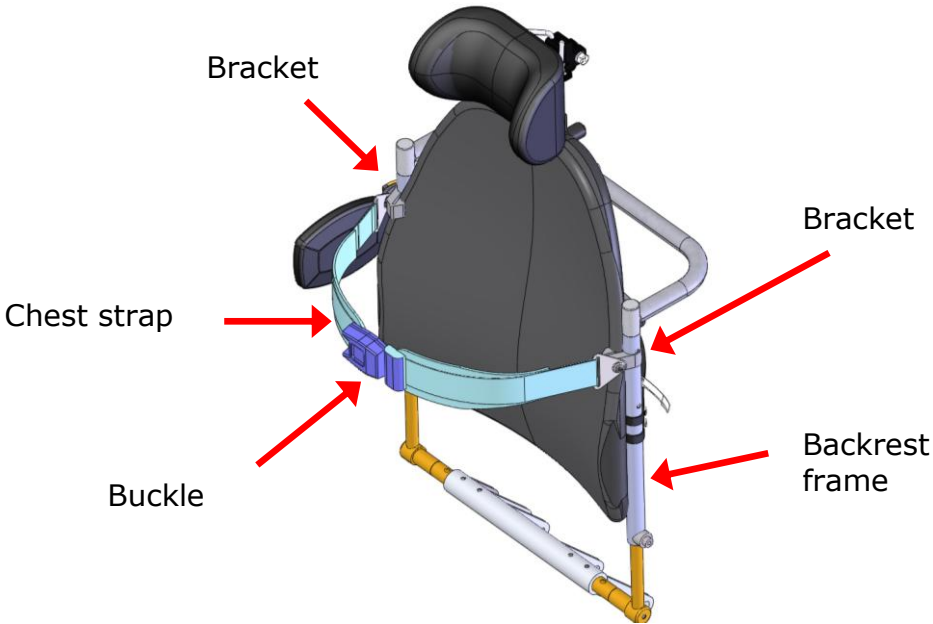

Pass the strap around to the front of the wheelchair and secure over your chest using the quick release buckle. (See picture 17c). Adjust the length of the strap so that it is not too tight but fits comfortably across your chest.

The length of the chest strap can be adjusted as follows. To loosen, hold the belt buckle at a right angle to the belt and pull. To tighten, buckle the belt together and pull on the end of the belt.

13 Using the LEVO combi

Warning: To avoid any risk of tipping over the LEVO *combi* must only be used in the stand-up position on firm level ground.

Before entering or leaving the chair, the joystick has to be OFF.

13.1 Getting into the wheelchair

- Make sure the wheelchair joystick module is switched off.
- Check if the motor disengaging lever is in the ON position for no movements of the powered wheels.
- Lift up the footplates.
- Transfer yourself onto the seat using the armrests for support or have yourself transferred onto the seat.
- Lock the footrests down and rest your feet on them.
- Fit the knee support and chest strap.

13.2 Getting out of the wheelchair

- Make sure the wheelchair joystick module is switched off.
- Check if the motor disengaging lever is in the ON position for no movements of the powered wheels.
- Remove the chest strap and knee support.
- Lift up the foot plates.
- Transfer yourself in your usual way out of the wheelchair or have yourself transferred out of the wheelchair.

13.3 Sideways transfer

- Drive as close as possible to a chair, bed or any other objects you want to transfer to.
- Make sure the joystick module is switched off.
- Check if the motor disengaging lever is in the ON position for no movements of the powered wheels.
- Flip up the footrest of the wheelchair and put your feet on the ground.
- Lift up the armrest on the side you are transferring to.
- Transfer yourself in your usual way out of the wheelchair or have yourself transferred out of the wheelchair.
- Lateral transfer is only in the complete sitting position of the wheelchair allowed.

13.4 Skirt guards



As an option there are skirt guards available. A skirt guard is put on either side of the seat plate. (See picture 18a). Mounting and dismounting can easily be done by hand. Please read the following instructions for taking the skirt guards off and see the pictures 18b to 18e. To put the skirt guards back in place follow the instruction in the reverse order.



Take the skirt guard with your hand at the front edge.



Lift the skirt guard.



Move the skirt guard backwards and down until the double-head screw is blocked by the left end of the jog.



Pull up the skirt guard the way that the double-head screw slides along the vertical jog and the guard can be completely removed from the chair.

14 Main fuse

The main fuse housing is under the chair cover in the rear.

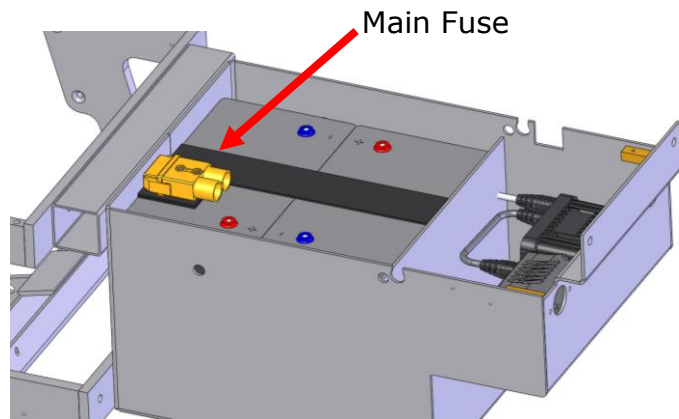

To get access, carefully open the cover as shown. Open the fuse cover, insert one of the two fuses which are delivered in a separate plastic bag and snap the fuse cover back.

Store the fuse cabling properly above the batteries by the attached Velcro strap.



15 Installation and replacement of the Main Fuse

To install or replace the main fuse, the chair has to be brought at least at 10° standing to open the cover at the rear side. Two fuses are in the scope of supply. You will get spare fuses by your dealer or a retailer.

If the current draw is too high, the fuse will melt.

16 Release and bring the seating system into standing

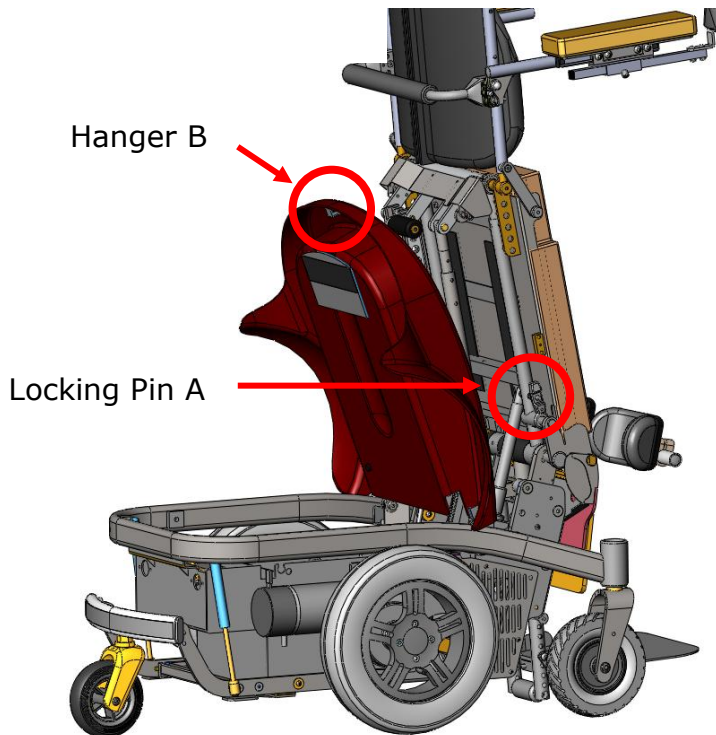

Take off the locking pin A and lift the seat into standing position.

Open the rear cover and fix it by a strap around the hanger B.

Take off the velcro fixed fuse device.

Replace the fuse according to the pictures and fix the fuse device onto the batteries.

Close the cover.

Drive out the actuator and fix it with the seat by the locking pin A.

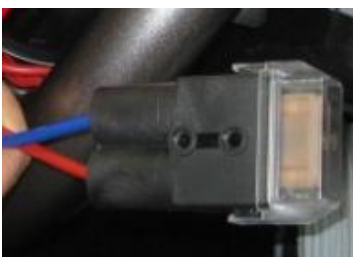

17 Steering

Warnings:

- Avoid knocking your joystick module and especially the joystick.
- Be careful not to drive the joystick module into obstacles.
- Avoid damage to cables.
- Do not let your joystick module get damp or contaminated with food or drink. If it gets damp or dirty clean it off as soon as possible.
- Always clean your joystick module with a cloth dampened with diluted detergent. Never use abrasive or spirit cleaners.

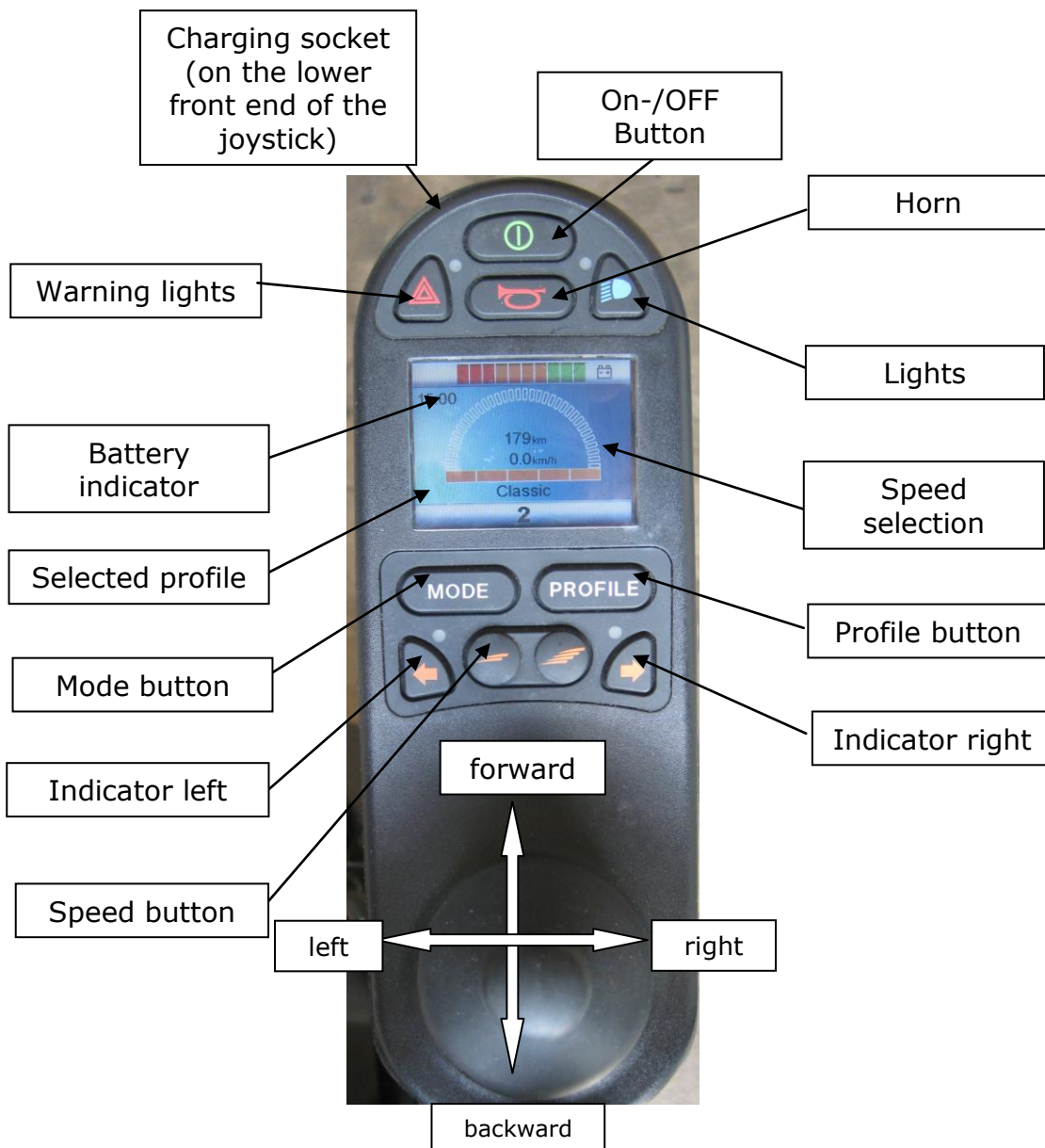

17.1 Security key

A security feature is built into your **LEVO combi** to lock your joystick module to prevent unauthorized use.

To lock: press the On/Off switch for 2 seconds; you should hear a beep then. Move the joystick to the front until you hear a beep. Then move the joystick backwards until you hear a beep. The wheelchair is now locked. The wheelchair cannot be driven and the standing function, as other functions, are disabled.

To unlock: press the On/Off switch, a lock should appear on the screen. Move the joystick to the front until you hear a beep. Then move the joystick backwards until you hear a beep. The wheelchair can now be driven and the standing function, as other functions, are enabled again.

17.2 On / Off switch

Press once to turn the joystick module on, press again to turn it off. (See picture 19).

17.3 Battery indicator

The battery indicator lights up when the joystick module is switched on (see picture 19). The indicator shows you the level of battery charge left in the batteries. (Also see section 16.1 charging the batteries). It also indicates any faults; details are given in section 22.

17.4 Joystick



The joystick controls the direction and speed of the wheelchair. The joystick is also used to choose the different mode functions. (See page 40).

To drive forwards push the joystick forwards. The further you push it from the centre the faster the wheelchair will move. Let go of the joystick and the wheelchair will stop and the brakes come on.

For backwards driving push the joystick backwards. Pushing the joystick to the right side means a right hand curve as a reaction. Pushing the joystick to the left then the chair will drive to the left hand side.

For information about choosing different mode functions please consult sector 11.6.

17.5 Speed selection

The display shows the present speed setting of the wheelchair. There are five speed settings. One light is lit for the slowest speed and five lights lit for the fastest speed.

To change the speed when stopped press the MODE button once then move the joystick to the right to increase speed (more lights lit) or to the left to decrease speed (less lights lit).

You can also change the speed while driving. Press the MODE button and the speed will be increased by one step. Repeated pressing of the MODE button will increase the speed until 5 lights are lit (maximum speed). If the MODE button is pressed once more the speed automatically returns to the slowest.

The maximum speed is 10/8/6 km/h respectively 6/5/3,7 mph. The lowest speed to drive (one light is lit) is approximately 40 % of its maximum.

For safety we advise you to change the speed when the wheelchair is stationary.

17.6 Mode functions

Please note absolutely 5. Warning and 6. Safety Harness

17.6.1 Standing function (standard)



The **LEVO combi** is supplied with a stand-up function to set the seat and the back of the chair upright for an almost completely upright standing position. (See picture 21a).



To operate the stand-up mechanism, with the wheelchair stopped, press the MODE button (see picture 19). Move the joystick to the left or right side until picture 21b appears. This way you select the mode for the standing function.

To raise the seat push the joystick forward. To lower the seat pull the joystick backward. To stop in any position between seated and well standing just let go of the joystick. To stand up to the full standing position, push the joystick forward until the mechanism switches off automatically. To lower the seat again just pull the joystick back towards you.

17.6.2 Lift function (option)



The **LEVO combi** can optionally be supplied with a lifting function to horizontally raise the seat up to 15 cm / 6".

To operate the lift mechanism, with the wheelchair stopped, press the MODE button (see page 40). Move the joystick to the left or right side until picture 22a appears. Then the lift function is activated.



To raise the seat, push the joystick forward. To lower the seat, pull the joystick backward. To stop at any level of sitting height just let go of the joystick.

To sit as high as possible, push the joystick forwards until the mechanism switches off automatically. To lower the seat again just push the joystick backwards.

17.6.3 Backrest and leg rest adjustment (option)



The **LEVO combi** with the option 90° backrest directly linked with 80° leg rest adjustment allows you to reach a lying position.

CAUTION: Improper balance and/or weight distribution can result in tipping over and causing serious injury or death when attempting to reach the lying- or Trendelenburg position. Trendelenburg position means that the feet will be above the head in an angle of approx. 11°. You absolutely must follow the safety precautions. Never drive in this Position!! Supervision and observation through an attendant person, wearing the safety belt, necessary fitting adjustments like leg rest, seat depth, backrest, headrest and gas spring force of the rear wheel are absolutely to observe!!

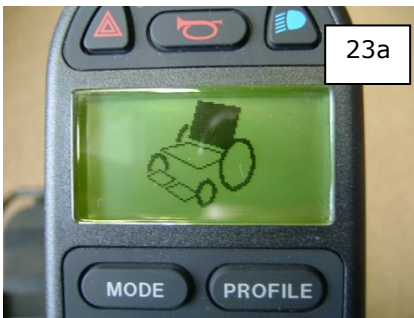

To adjust the backrest and leg rest press the MODE button (see page 40). Move the joystick to the left or right side until picture 23a appears. Then the back- and leg rest adjustment is activated.

To get in a reclining or lying position, pull the joystick backwards.

To get back into the sitting position or in a more upright sitting position, just push the joystick forwards. To stop in any position between sitting and lying, let go of the joystick.

24



To be transferred in a total horizontal lying position (see picture 24; including optional armrest reclining) pull the joystick backward. If the horizontal position is reached let go of the joystick. If the seat height is in basic ground position the mechanism switches off automatically.

CAUTION: If the seat height is not in basic ground position, you would reach the Trendelenburg position. Consider the weight and or the balance point shift under 5. Warning!

To sit upright again just push the joystick forwards. (Operate all these functions with the wheelchair stationary.)

For an easy transfer in the lying position (for example from the bed to the wheelchair or versus) use the lift function (optional function) to put the chair on an equal height as the other object.

17.6.4 Leg rest adjustment (option)



The LEVO *combi* with the option leg rest adjustment allows a stepless and comfortable position.

Combined with leg rest adjustment and relax function it is possible to reach every position until lying.

To adjust the leg rest press the MODE button (see page 40). Move the joystick to the left or right side until picture 25 appears. Then the leg rest adjustment is activated.

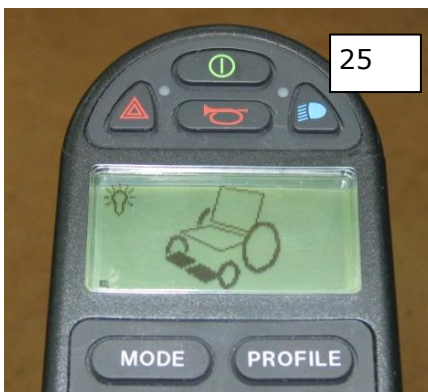

To raise up the legs just push the joystick forwards. To stop in any position between, let go of the joystick. Otherwise the mechanism switches off automatically

To lower the legs just push the joystick backwards. To stop in any position between, let go of the joystick. Otherwise the mechanism switches off automatically.

17.6.5 Lying to standing function (option)



The option lying to standing moves the chair from a horizontal position directly to a total upright position. To activate this function, press the MODE button (see page 40). Then press the joystick a few times to the left or to the right until picture 26 appears. Then the lying to standing function is activated.

To raise the back and the seat plate to transfer into an upright position push the joystick forward. To return into the lying position or in a less upright position, just pull the joystick backward. To stop in any position between lying and standing, let go of the joystick.

To reach the completely upright standing position (see picture 26), push the joystick forward until the mechanism switches off automatically. To lie down again, just pull the joystick backward and let of the joystick when you feel comfortable. Consider the weight and or the balance point shift under 5. Warning!



Operate all these functions with the wheelchair stationary!

17.6.6 Relax position including seat tilt (optional)



This position called "relax" is a further option which allows a most comfortable position for activities as reading, listening to music, watching TV or just relaxing. This function can only be operated with the options "backrest reclining" and "seat lift" (when the user's seat height is rather high this option works limitedly without the seat lift function). (See page 40.)

Being in the position with a comfortable seat tilt is the initial position to relax. Please read in chapter "seat tilt" the description how to tilt your seat. Now check if there is a red indicator light on the wheelchair symbol. If not, press the MODE button (see picture 19) until a red indicator light is on the seat of the wheelchair symbol. Move the joystick to the left or right side until the indicator light points only at the back of the wheelchair symbol. This way you select the mode for the backrest reclining function. Pull the joystick backwards and you will be moved to the relax position. To stop when you feel comfortable, just let go of the joystick.

17.6.7 Seat tilt function (option)



The option seat tilt is only possible with the option seat lift. Depending on the seat height of the **LEVO combi** and the space between seat plate and cover of the batteries it allows you to lower the seat plate at its back end to get into a more stable position which is especially appreciated for driving. (See picture 26.)

There are two steps needed to tilt the seat. Press the **MODE** button until the red indicator light comes on at the wheelchair symbol just set at the seat. Now the seat lift is activated. Push the joystick forward until the maximum seat height is reached and the mechanism switches off automatically. Then move the joystick to the left or right side until the indicator lights are at the back and the seat of the wheelchair symbol. Pull the joystick backward and the seat plate will lower at its back end. Let go of the joystick if you feel to be in a comfortable position. This mechanism will switch off automatically as soon as the seat plate touches the cover of the batteries. Then the seat reached its maximum tilt angle.

17.7 Lighting installation

The lighting installation of the **LEVO combi** includes two white lights pointing forwards and two red lights pointing backwards as well as four indicators.

Light

Press the light switch in case of driving outside at night or at dawn. We recommend driving with the lights on as soon as there are bad light conditions so that you can be seen by anyone.

Important: Please notice that the capacity of the batteries is affected by using the lights.

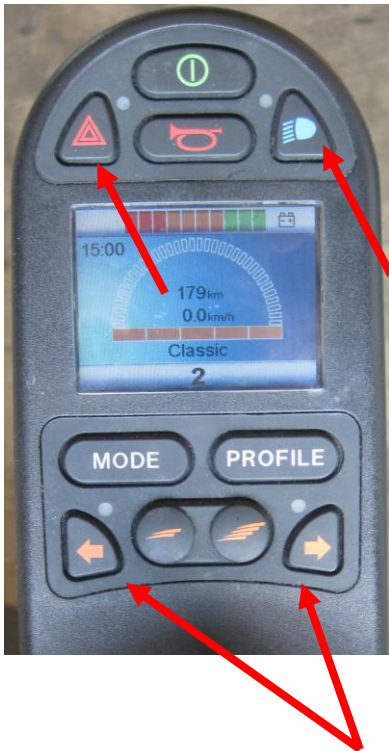

Indicator

Press the right indicator switch any time you like to turn right. After turning switch off the indicator by pressing the same switch again.

Press the left indicator switch any time you like to turn to the left hand side. After turning switch off the indicator by pressing the same switch again.

Flashing warning light

Press the switch for the flashing warning lights (see picture left) for parking at blind and dangerous spots. Switching on the flashing warning lights all four lights blink. Press the switch again for deactivating these lights.

Check the function of all lights at regular intervals. Repair any fault found.

17.8 Horn

To warn other people of your presence press the horn button and the warning horn will sound. Please be careful when using the horn. Repeated and inappropriate use will only upset those around you. Only use the horn as a warning to other people and not as a way of getting them to move out of your way.

18 Electromagnetic interference (EMI)

Important: You must be aware of the effect of electromagnetic interference (EMI) regarding your LEVO combi. Please study the following facts carefully.

Electromagnetical interference of transmitter and radio wavelength

Powered wheelchairs might be influenced by strong electromagnetic interference. This interference is caused by radio and TV stations, amateur radio sets (walkie-talkie), two-way radios and mobile phones. Interference (especially of radio stations) might have an influence on the brakes of a powered wheelchair so that they get released and so the chair runs away. It could also happen that the wheelchair starts driving in a none desired direction or the stand-up function could operate non-requested. Constant damages could occur to the steering system of the powered wheelchair.

The intensity of power is measured in volt per meter (vpm). All powered wheelchairs are able to resist to a certain amount of electromagnetic interference. This is called "level of disruptive strength". The security depends on the level of disruptive strength; the higher the level the better the protection. Thanks to modern technology the capability of disruptive strength is up to 20 vpm.

The **LEVO combi** standard version (no further measures) is supplied with a disruptive strength level of 20 vpm.

The **LEVO combi** is constructed to resist to a regular level of interference as it occurs in a household. Besides that there exists a certain number of sources of relatively strong magnetic fields to which you should stay in a safe distance. Some of these magnetic fields are obvious and easy to avoid. Some other are not easy to be realized and it is hard to stay off at times. Please take knowledge of the following list of sources of interference and avoid getting close to these disruptive factors. The EMI-risk is reduced to the minimum when you follow these instructions.

The sources of radiated EMI is put in three categories:

- Portable sender and receiver on which an aerial is directly mounted. Examples: CB-radio, walkie-talkie, sender and receiver of alarming systems, fire alarm, police, radio equipment, mobile phone and various private communication systems.
- Please notice: Some mobile phones and similar objects transmit signals as soon as they are switched on even if they are not in use at the moment. There have not been any known incidents caused by mobile phones to date.
- Mobile sender and receiver of intermediate range, as they are installed in police cars, fire engines, ambulances and cubs. The aerial is normally fixed on the outside of the vehicle.
- Sender and receiver of a huge range, as radio and TV stations and amateur radio sets.

Be aware that wireless phones, lap tops, AM/FM-radios, TVs, CD players, recorders as well as gadgets like razors, hair dryers and so on are only small sources of electromagnetical interference. These objects don't cause any problems regarding the functionality of the **LEVO combi**.

Electromagnetic interference in regard to a powered wheelchair
Considering that electromagnetic power reaches high intensity in just a short time as soon as you get close to the source, it is advised to take special care carrying a sender and receiver with you. It might occur that an item as mentioned gets very close to the controller of the wheelchair and like that electromagnetic energy gets unintendedly too close too. In this situation the electromagnetic energy might influence negatively the function of brakes as well as the motion characteristics of the wheelchair.

19 Electromagnetic energy (EME) and electric wheelchairs

Because electromagnetic energy (EME) quickly achieved a high level of intensity when a transmitter (source) approaches, you should be especially careful when wearing transceiver systems. EME emanating from a wheelchair, can also misconduct of electrical lead devices in the vicinity of the wheelchair.

Caution is also needed in the vicinity of alarm systems, automatic doors, etc. It is possible that unintentionally EME in a large extent is very close to the control of an electric wheelchair. This affects the movement and the braking of the wheelchair. Such EME sources are for example Mobile phones, power generators or high voltage sources.

19.1 Behavior regarding EMI and EME

Adhering to the following guidelines reduces the risk that the brakes on the wheelchair that the wheelchair released unintentionally or accidentally set itself in motion.

Note such situation in your environment and avoid it to get into vicinity of radio or TV stations.

If your wheelchair is uncontrollably or the brakes are released accidentally set into motion, turn off the wheelchair as soon as it is safely possible.

Inform LEVO of any incident of uncontrolled movement or involuntarily dissolved brakes and note whether a radio wave transmitter was in the near.

Bear in mind that any change in the electric chair or the assembly of accessories or components may make the wheelchair more susceptible to EMI. LEVO accepts no responsibility for the effects of EMI if your wheelchair has been modified in any way.

20 Driving the wheelchair

Before starting to drive your wheelchair take time to read all the instructions regarding the **LEVO combi** and to get to know the controls. When first learning to drive your wheelchair, practice in an area you know well. We suggest a large flat smooth area such as your living room or the driveway to your home. Do not attempt to drive the wheelchair in confined areas or where there is traffic until you are sure you can control the wheelchair safely.

When driving outdoors always have the seat plate in a horizontal position or tilted backwards (in case seat angle tilt is an optional function).

Switch on the joystick module and practice driving the wheelchair slowly forwards, backwards and turning side to side. When you have more confidence increase the speed and practice until you have mastered driving the wheelchair.

It is possible to drive the wheelchair in the standing position. Speeds are cut to half the speed as soon as the seat leaves the lowest seat position. When indoors practice standing up in the wheelchair and slowly driving it across the room.

The wheelchair allows you to drive absolutely safely in a sitting position on slopes with a maximum gradient up to 10 degree. When driving up or down steeper slopes than this or over uneven ground, braking and steering response will be limited due to reduced traction. When on a slope don't lean out of the wheelchair down the slope. Danger of tipping.

Driving in a standing position is no problem up to a gradient of 3 degree.

A limit switch with some important security features programmed is a standard of the **LEVO combi**. In correlation of the current position of the chair and the inclination of the ground the speed is automatically reduced. In extreme situations the system prohibits to continuing driving for the safety of the user. It is be possible to go on as soon as the seat plate is lowered. Please read the detailed information below.

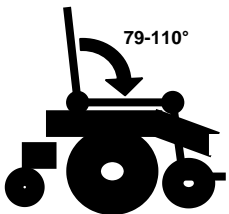

Chair drives up to 100% of maximum speed

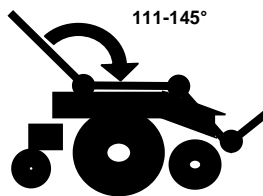

Chair drives up to 40% of maximum speed

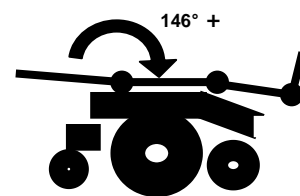

Chair drives up to 10% of maximum speed
Only use under observation of an attendant person

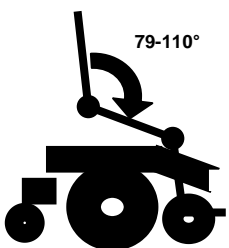

Chair drives up to 100% of maximum speed

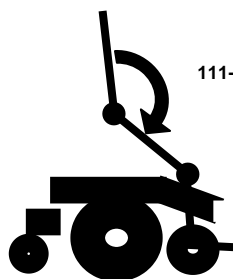

Chair drives up to 40% of maximum speed

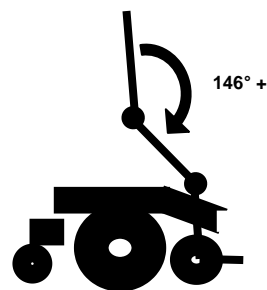

Chair drives up to 10% of maximum speed

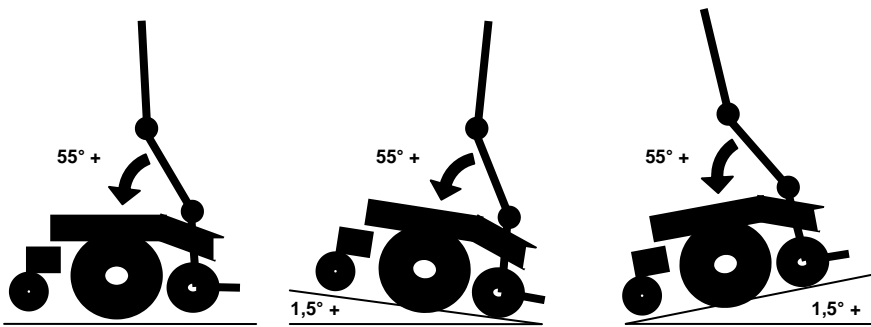

Chair drives! Gradient: Chair stops!

Slope: Chair drives!

The test (TUV, Germany) of the stability of the LEVO *combi* while *not* in motion proved the following results:

Sitting position facing downhill	12,5 degree
Standing position facing downhill	10 degree
Sitting position facing uphill (front wheels not touching the ground at the max., but still 100% of stability)	18 degree
Sitting position crossways direction	16 degree
Sitting position 45° to the horizontal direction	9 degree

Always approach small obstacles such as dropped curbs, ruts and thresholds at the right angle. Always drive over obstacles slowly to avoid jolting or tipping.

The **LEVO** *combi* has a curb climbing ability of maximum 6 cm / 2,4" being in a sitting position and 4 cm/1.6" being in an upright standing position.

Prevent the risk of overheat. Do not strain your motor too hard. Take care when climbing steep slopes at full speed for a far distance.

Warning: Never drive the wheelchair in the standing position outdoors or over obstacles.

Please be attentive and always face ahead while driving. Watching what is going on around you with concentration leaves you enough time to react in case of an unexpected obstacle. Taking care like that helps to avoid accidents.

Please watch for passengers, children, dogs and so on close to you and ahead of you because they intend to stop or change direction unexpectedly.

Never switch off the joystick module while driving the wheelchair. If you do, the wheelchair will stop instantly and there is a danger of being thrown out of the wheelchair. Always let go of the joystick and the wheelchair will stop smoothly.

If you think that you cannot find a maximum speed control setting that suits you, the control system can be programmed to meet your needs.

Warning: Programming should only be conducted by healthcare professionals within depth knowledge of Penny & Giles electronic control systems. Incorrect programming could result in an unsafe set-up of a wheelchair for the user.

LEVO AG accepts no liability for losses of any kind if the drive or stability characteristics of the wheelchair are altered without prior notification and discussion with LEVO AG.

Important: Please ask for the regulations of your country considering the admittance for the usage of the roads regarding the wheelchair as a vehicle taking part of the traffic. These regulations vary in each country

23 Batteries

Your wheelchair is supplied with maintenance free, dry rechargeable batteries. They do not require any maintenance by the user other than regular charging.

23.1 Charging the batteries

Your wheelchair is supplied with a 24 Volt automatic battery charger (PowerFirst PF2408) that is easy to operate.

Charge the batteries at a time convenient to you. We suggest over every night. Always charge the batteries when the battery gauge indicator on the joystick-power module is showing or flashing one bar lit.

Also if you are not going to use your wheelchair for some time charge the battery before storing the chair and at intervals of 4 weeks for 12 hours whilst the chair is being stored. Before using the chair again charge the batteries first for 12 hours.

Notes: The wheelchair cannot be driven when the charger plug is connected.
The battery will not be charged if the joystick is ON.

To charge the battery, insert the round plug on the lead from the battery charger into the socket beneath the front of the joystick-power module. Plug in the main plug into a 110/220 Volt socket.

On each Power Charger there are LED indicators, which show the status of the charging, the Charger or the power supply. Please note the information on this label.

LED's controls and indicators

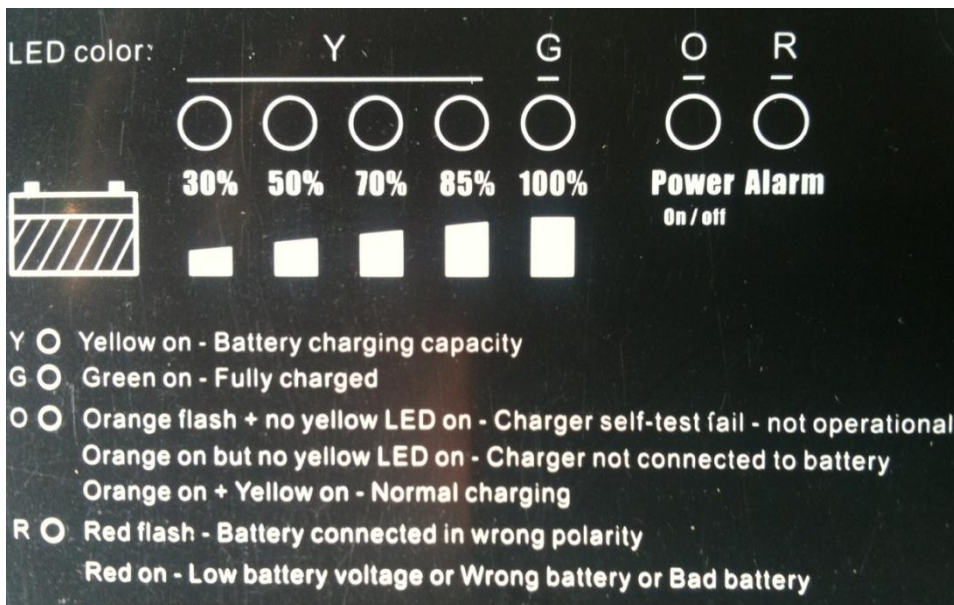

If the charging is finished please switch first the charger OFF and take off the plug out of the 110/220 Volt socket.

If the batteries are too deep discharged, they might be damaged.

If a deep charge occurred charge the battery as soon as possible for 24 hours.

23.2 Battery Wiring

Following label which is below the battery cover shows the correct wiring of the battery.

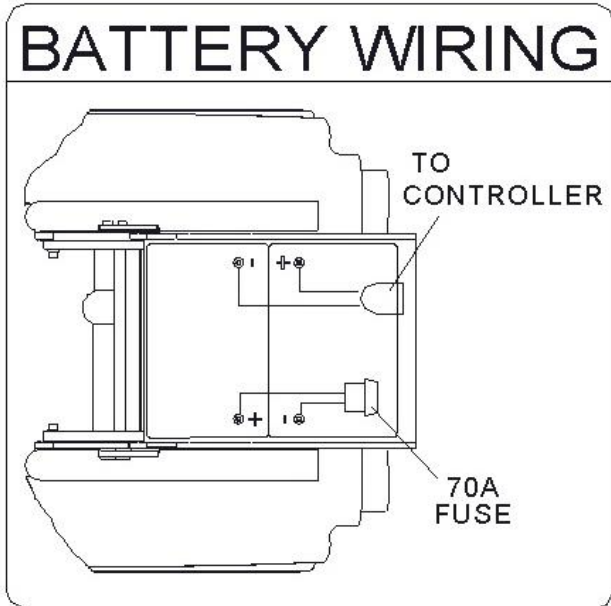

24 Attendant instructions

24.1 Motor brakes

Always make sure the motor disengaging lever is in the ON position (motor brakes activated) when helping the user to get into or out of the wheelchair or when leaving the user unattended. For more information about the motor disengaging lever consult sector 15.

24.2 Lifting & general safety

Never try to lift the wheelchair when the user is sitting in it. For your own safety never lift the empty wheelchair by yourself. Because of the weight and size of the wheelchair two people must lift it. It helps if you remove the footrests, backrest/headrest and batteries before lifting.

24.3 General safety

The wheelchair is designed to be used by one person only. Never allow children to play on the wheelchair or stand on the footrests or battery cover plate.

25 Cleaning

- Whenever the wheelchair gets dirty it should be cleaned using a damp cloth and then dried thoroughly.
- For more stubborn stains wipe with a damp cloth using a mild solution of warm water and a mild cleansing agent.
- Never use furniture polish, spirit or solvents to clean the frame.
- In case of dirt on the seat cushion cover or the back rest cover, you can remove both of it and wash it softly. Do not wash it warmer than **40 degree Celsius**.

25.1 Disinfection

Please use alcoholic spray for surface disinfection like „Germex Spray from Pramol-Chemie “.

25.1.1 Parts to be disinfected

- Armrest including Joystick
- Backrest
- Seat
- Leg rest
- Footrest
- Knee Support

25.1.2 Disinfection procedure

- Cover all chassis metal parts to protect it of corrosion.
- Clean all listed parts with water or better with soap water.
- Spray all listed parts with disinfection medium and let it stay for few minutes.
- Dry it completely.

26 Maintenance

26.1 Checks and Service

The **LEVO combi** is designed to be maintenance free and apart from the items below does not require attention from the user. Please note that to maintain safe and efficient operation the wheelchair should be serviced at least once per year by your **LEVO** agent or authorized dealer.

The user or their family can easily carry out the following tasks.

- Keep the wheelchair clean.
- Never store the wheelchair when damp.
- Keep the batteries charged to the maximum.
- Check if all adjustments and fixations, harness, etc. are working properly (see section 6. - 9.).
- Check operation of motor disengaging lever weekly.
- Check operation of all controls daily.
- If any faults are found, report them immediately to your agent. He will advise you whether to continue using the wheelchair or not, and what action you should take to repair the wheelchair.

26.2 Spare parts

LEVO AG **delivers single parts or modules as spare parts. Your distributor can provide all spare parts listed for your LEVO combi. You have also the opportunity to see the spare part lists on our Homepage www.levo.ch .**

27 Transporting your wheelchair

27.1 Transport in a motor vehicle without person inside

When transporting the **LEVO combi** in a motor vehicle assure that the wheelchair is secured as to prevent it sliding about or tipping over. Use licensed fastening systems which secure the wheelchair's rear axle and the lower frame tubes from below.

To minimize the needed space, some parts and components could be flipped or taken off according 7.1.

The driver is responsible for correct fixation in the car.

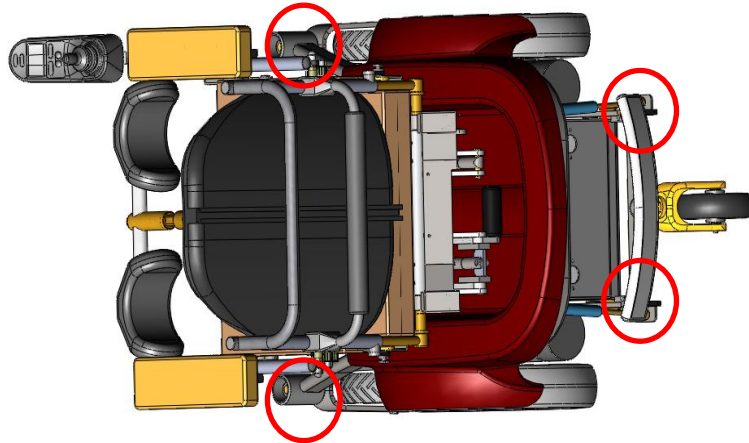

27.2 Transport in a motor vehicle with person inside

The **LEVO combi** has been positively crash tested for car transportation after the norms **ISO 7176/19** and **ANSI/RESNA WC/Vol. 1-Section 19**.

Please make sure, that the **LEVO combi** is as follow equipped before using it for car transportation:

- **The chair has to be equipped and reinforced with the "QLK-100 / EZ Lock brackets #32.068.2050" and with a "seat lock down system" that can be ordered at LEVO AG through your LEVO distributor (see instructions below)**
- **The chair has to be safely locked into the QLK-100 or EZ Lock system assembled and installed by an authorized Q'Straint or EZ Lock agency. There are similar products like QLK-100 available in the market. To get authorization of using other system then QLK-100, please contact any such locking system manufacture directly**
- The seat has to be in a safely locked seat down position before driving the car.
- The occupant has to be safely secured by using the Q'Straint Vehicle Anch 3-Pt or any restraint system that has been tested and passed the ISO 10542/2 standards.

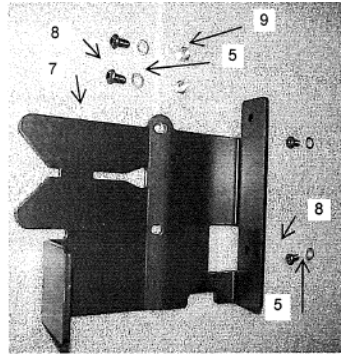
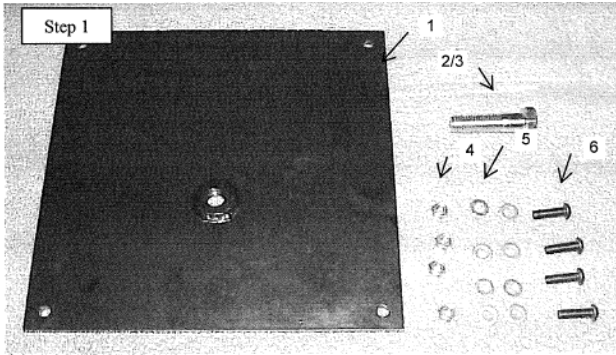

Pos.1	ez-lock base plate	30.102.4560	1 pcs.
Pos.2	hexagon head screw M16x60	10.016.5628	1 pcs.
Pos.3	hexagon nut M16	10.057.0012	1 pcs.
Pos.4	hexagon nut M8	10.057.0408	1 pcs.
Pos.5	washer for M8	10.050.0048	10 pcs.
Pos.6	hexagonal oval-head screw M8x25	10.007.8817	4 pcs.
Pos.7	stabilizer plate	30.102.4020	1 pcs.
Pos.8	hexagon cyl. screw M8x16	10.005.8812	4 pcs.
Pos.9	hexagon press nut M8	10.067.0203	2 pcs.

QLK-100 / EZ Lock
Brackets # 32.068.2050

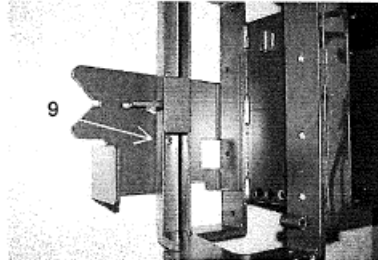
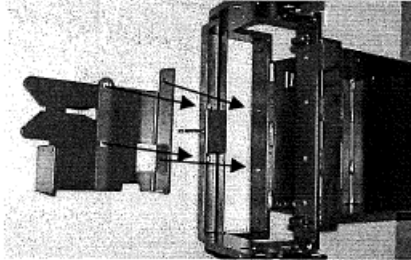
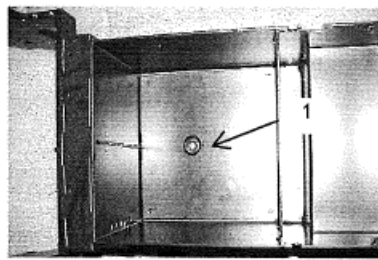
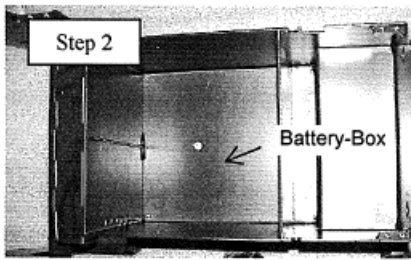

- place Pos. 1 into the battery box
- drill the 4 holes in the corners
- diameter = 9 mm
- recolor blank parts with black
- assemble all parts (picture 4)
- the head of screw M16x60 has to be under the wheelchair

- set "press nut" into the frame of battery box (picture 9 / pos. 9)
- diameter = 9 mm
- assemble pos 6 and battery box together (from front side) (see picture 5,8 and 9)

Step 3 Some original QLK-100 and EZ-Lock parts to be installed by an authorized agency in the car (also see their manuals).

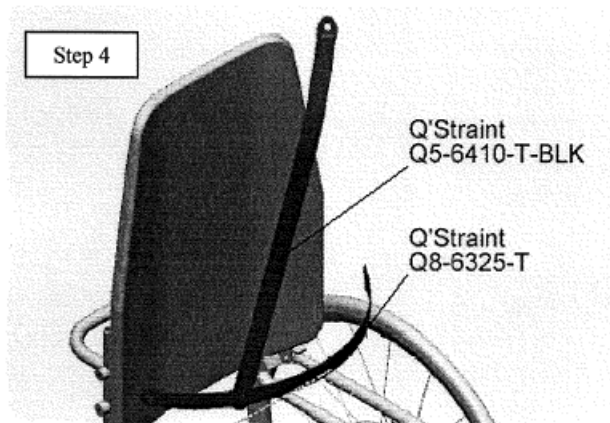
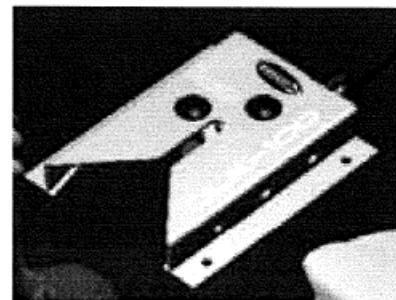
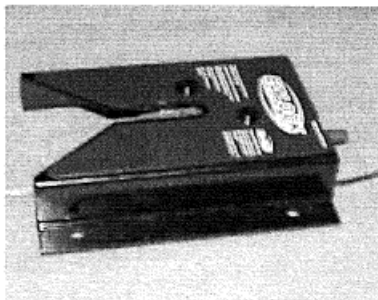
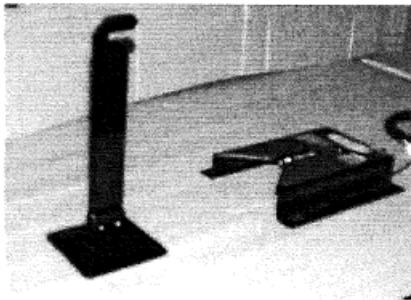

28 Disposal

Return the wheelchair after the product lifetime to the sales point. The dealer will dispose of it according to local regulations. Regarding the possibilities for individual adjustments your **LEVO combi** might be of use to another stand-up wheelchair user. Return old batteries to the sales point of the wheelchair or of the new batteries. The dealer will dispose of them according to local regulations.

29 Trouble shooting

If you have problems with your wheelchair check this list before calling your local agent.

ITEM	PROBLEM	SOLUTION
Joystick module	Battery level indicator does not light	<ul style="list-style-type: none"> Switch on ON/OFF switch Switch on safety cut out Unplug charging plug Replace battery If above does not work consult LEVO agent
	Battery level indicator flashes slowly	<ul style="list-style-type: none"> Charge Battery
	Battery level indicator blinks every 2.5 Seconds	<ul style="list-style-type: none"> Joystick module in sleep mode. To restart switch off then on again.
	Battery level indicator flashes rapidly	<ul style="list-style-type: none"> See section 23 below
Driving	Will not drive in a straight line	<ul style="list-style-type: none"> Consult LEVO agent
	Motors turn and battery level indicator lights up but chair does not drive	<ul style="list-style-type: none"> Make sure motor disengaging lever is pushed fully forwards. Charge batteries
	Motors do not turn but battery indicator lights	<ul style="list-style-type: none"> Charge batteries On steep slope, set speed at max. Consult LEVO agent
Stand up Mechanism	Mechanism does not respond	<ul style="list-style-type: none"> Select stand-up mode on the joystick module Charge batteries Consult LEVO agent
Battery charger	LED 1 does not light	<ul style="list-style-type: none"> Plug in main plug Check household fuse
	LED 1 lights but no other LED lights up	<ul style="list-style-type: none"> Consult LEVO agent
	LED 1 lights, LED 2 flashes immediately	<ul style="list-style-type: none"> Check charging plug is inserted Check safety switch is on Consult LEVO agent
	LED 1 lights, LED 2 continues flashing after lengthy period of charging (> 16 h)	<ul style="list-style-type: none"> Replace battery Consult LEVO agent
	Red Polarity lamp lights	<ul style="list-style-type: none"> Unplug charger immediately Consult LEVO agent

30 Controller self help guide

The joystick module has its own error-management-system. If an error occurs, a message is indicated on the display, for example this could look like that:

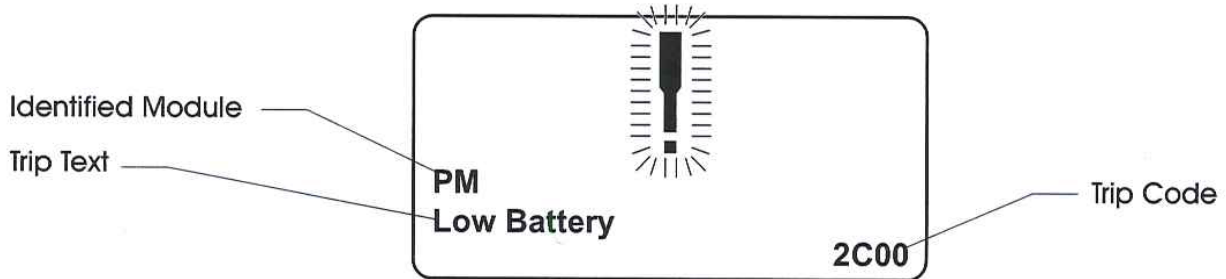

If you can't solve the problem, just with the showed message, you can enter the trip code on the PG Drives homepage (<http://www.pgdt.com/diagmob/diagnostic.asp>), there you'll get some more information about the error and how you can solve it. If you can't solve the problem, please get in touch with your **LEVO**-dealer.

31 Technical information

Model	S-M		L-XL	
Wheelchair category	B (motorized driving / motorized standing)			
Seat width	38 / 44 / 50 cm; 15 /17/20“			
Seat depth adjustable (incl. leg protector)	36 - 47 cm; 14 – 18,5“		47 - 58 cm; 18,5 – 23“	
Seat height (from top of cushion)	56 - 71 cm; 22 – 28“			
Armrest height (from top of cushion)	11 - 27 cm; 4 – 11“			
Footrest height (from top of cushion)	37 - 58 cm;14,5 – 23 „			
Footrest	height and angle adjustable			
Overall height without back rest upholstery	113 cm; 44.5“			
Overall height including back and head rest	140 cm; 55.5”			
Overall width	66 cm; 26“			
Overall length without footrest	76 cm; 30“			
Overall length including footrest	110 cm; 43“			
Smallest turning circle	110 cm; 43“			
Type of tire	breakdown safe, without air			
Size of tire	front 19.5 cm; 8“	middle 35 cm; 1’	rear 12.5cm; 5“	
Speed	0 – 10 km/h / 6mph			
Range (55 Ah batteries)	35 km; 22 miles			
Max. gradient (sitting position)	10°			
Max. gradient (standing position)	3°			
Kerb climbing ability (sitting position)	6 cm; 2,4“			
Kerb climbing ability (standing position)	1 cm; 0,4“			
Max. weight	170 kg; 375 lbs			
Max. total load	120 kg; 265 lbs			
Batteries	48 Ah			
Battery charger	24 V DC - 8A			
Joystick module	PGDT R-Net			
Programming of driving characteristics	Standard for trained	Classic for new comer	Fun for experts	
Colour	standard: red, yellow, blue, platinum, black			
	optional: metallic colours yellow, red, blue, silver	optional: 184 other colours of the RAL-offer	optional: 5 different reflex colours (turquoise, orange, lemon, white, silver)	optional: chrome

32 Versionsmanagement

Version No.	Date	Description	Autor
1.0	2012.07.30	First Edition Combi 923	B.Maurer
1.1	2014.03.10	Declaration of Conformity – Status TÜV Renewal Certification	H. Bögli
1.2	2014.06.02	TÜV Certification Update finalized	H. Bögli